

Panel-mounting valves and actuating attachments

Key features



Mushroom pushbutton with detent PR

The actuator is unlocked by turning the detent ring at the mushroom button.

Mushroom pushbutton with detent PRS Lockable

After pressing, the button remains locked and can only be unlatched with the key. The key can be removed in either switch position.

Key actuator Q With key

The key actuator can only be activated with the key. The key can be removed in either switch position.

Basic valve SV-3-M5

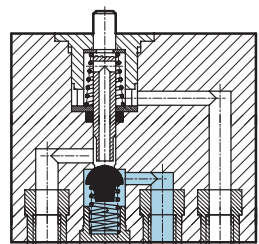

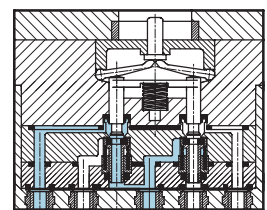

Basic valve SV-5-M5-B



Panel-mounting valves and actuating attachments

Technical data

-  Flow rate
65 ... 95 l/min
-  Pressure
-0.9 ... +8 bar
0 ... 8 bar
-  Temperature range
-10 ... +60 °C

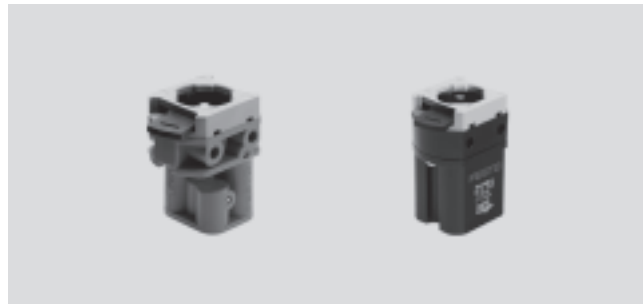

General technical data – Basic valves		
Function	3/2-way valve	5/2-way valve
Operating medium	Filtered compressed air, lubricated or unlubricated Vacuum ¹⁾	
Constructional design	Poppet valve, directly actuated in one direction, with spring return	
Type of mounting	Front panel mounting, mounting diameters 22.5 and 30.5 mm, also 2 through-holes	
Pneumatic connection	M5	
Nominal size [mm]	2	2.3
Standard nominal flow rate 1 > 2 [l/min]	65	95
Operating pressure range [bar]	-0.95 ... +8	0 ... +8
Actuating force at 6 bar [N]	12	17
Temperature range [°C]	-10 ... +60	
Materials	Housing	Plastic
	Valve stem	Brass
	Seals	Nitrile rubber
Weight [g]	40	53

1) SV-3-M5: Vacuum connection at port 1

General technical data – Actuator attachments									
		Pushbutton actuator	Mushroom pushbutton	Mushroom pushbutton with detent		Selector switch	Toggle switch	Key actuator with key	
				Red	Red Lockable				
Actuating force / actuating torque at 6 bar	[Nm]	14	14	25	23	0.4	0.14	23	
Weights	Installation diameter 22.5	[g]	14	20	26	82	21	19	80
	Installation diameter 30.5	[g]	22	28	37	91	30	27	88

Panel-mounting valves and actuating attachments

Technical data

Dimensions – Basic valves

Download CAD data → www.festo.com

SV-3-M5

SV-5-M5-B

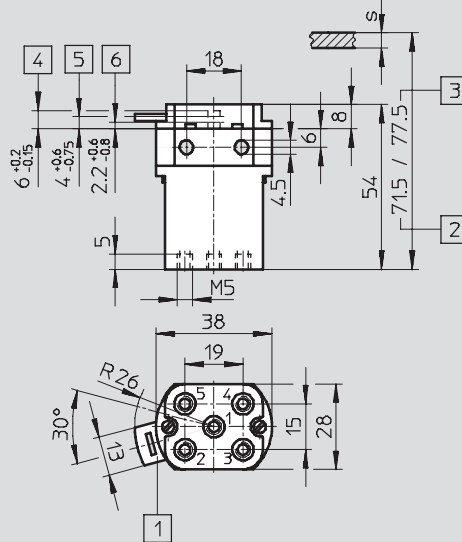
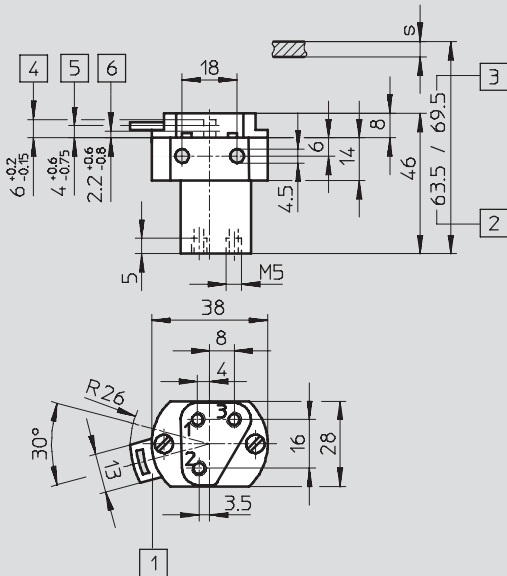

- 1 Quick latching coupler for actuator attachments
- 2 Installation dimensions for $\varnothing 22.5$
- 3 Installation dimensions for $\varnothing 30.5$
- 4 Max. stroke
- 5 Start of opening
- 6 Max. opening
- s Front panel thickness

- 1 Supply port
- 2, 4 Working line
- 3, 5 Exhaust

Mounting aperture

Installation diameter 22.5

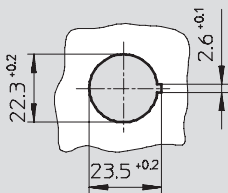

Installation diameter 30.5

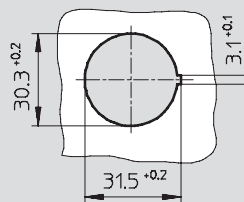

Dimensions – Actuator attachments

Download CAD data → www.festo.com

Installation diameter 22.5

Pushbutton actuator T-22

Mushroom pushbutton P-22

Mushroom pushbutton with detent, lockable PR-22

Mushroom pushbutton with detent, lockable PRS-22

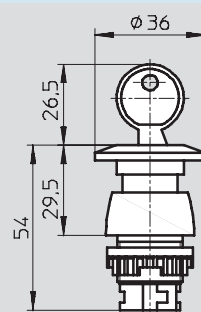
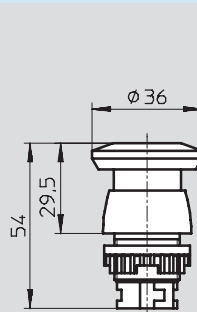
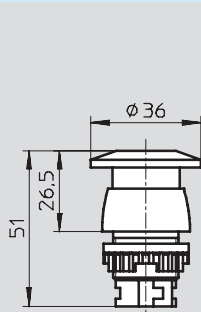
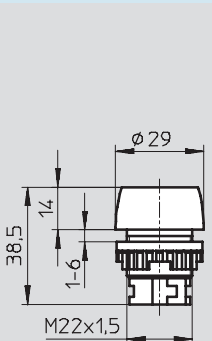

Panel-mounting valves and actuating attachments

Technical data

FESTO

Dimensions – Actuator attachments for front panel mounting

Download CAD data → www.festo.com

Installation diameter 22.5

Selector switch N-22

Toggle switch H-22

Key actuator Q-22

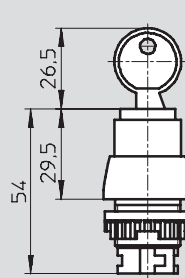
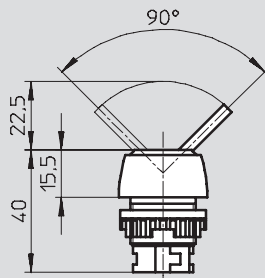
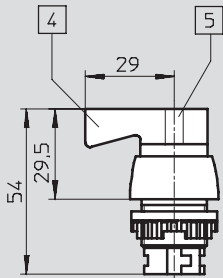

Installation diameter 30.5

Pushbutton actuator T-30

Mushroom pushbutton P-30

Mushroom pushbutton with detent,
lockable PR-30

Mushroom pushbutton with detent,
lockable PRS-30

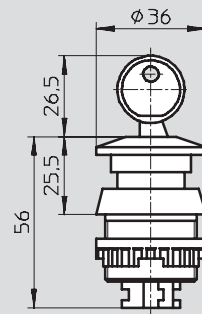
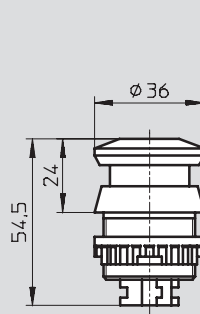
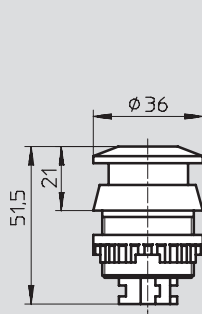
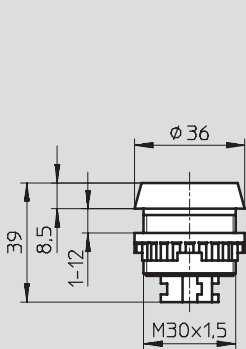

Installation diameter 30.5

Selector switch N-30

Toggle switch H-30

Key actuator Q-30

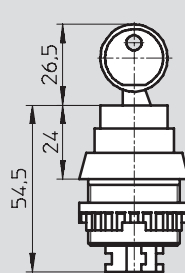
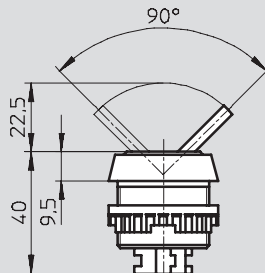
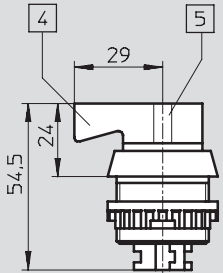

Type N

4 = Off

5 = On

Type PR

The actuator is unlocked by turning the detent ring at the mushroom button.

Type PRS

After pressing, the button remains locked and can only be unlatched with the key. The key can be removed in either switch position.





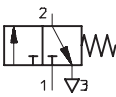
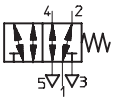

Type Q

The key actuator can only be activated with the key. The key can be removed in either switch position.

Panel-mounting valves and actuating attachments

Technical data

Ordering data – Basic valves			
Circuit symbol	Description	Part No.	Type
	3/2-way valve	6817	SV-3-M5
	5/2-way valve	11 914	SV-5-M5-B

Ordering data – Actuator attachments					
Circuit symbol	Description	Installation diameter 22.5		Installation diameter 30.5	
		Part No.	Type	Part No.	Type
Pushbutton actuator					
	Black	9 289	T-22-SW	9 291	T-30-SW
	Yellow	9 290	T-22-GE	9 292	T-30-GE
	Red	9 997	T-22-RT	10 014	T-30-RT
Mushroom pushbutton					
	Black	9 293	P-22-SW	9 295	P-30-SW
Mushroom pushbutton with detent					
	Red	9 297	PR-22-RT	9 298	PR-30-RT
	Red, lockable	9 299	PRS-22-RT	9 300	PRS-30-RT
Selector switch					
	Black	9 301	N-22-SW	9 302	N-30-SW
Toggle switch					
	Black	9 305	H-22-SW	9 306	H-30-SW
Key actuator with key					
	-	9 303	Q-22	9 304	Q-30