

Stepper motors EMMS-ST

FESTO



Festo core product range
Covers 80% of your automation tasks

Worldwide:

Always in stock

Superb:

Festo quality at an attractive price

Easy:

Reduces procurement and storing complexity

★ Generally ready for shipping ex works in 24 hours
Held in stock in 13 service centres worldwide
More than 2200 product

★ Generally ready for shipping ex works in 5 days
Assembled for you in 4 service centres worldwide
Up to 6 x 10¹² variants per product series

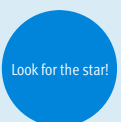

Stepper motors EMMS-ST

Key features

FESTO

Everything from a single source

Stepper motors EMMS-ST

→ page 4



- Corresponds to IEC 60034
- 2-phase hybrid technology
- Optionally integrated encoder (closed loop)
- Sinusoidal current impressing
- Optionally with holding brake
- Protection class: IP54



Gear unit EMGA-SST

→ page 13



- Planetary gear unit
- Gear ratio $i = 3$ and 5 , available ex-stock
- Other ratios and versions on request
- Life-time lubrication
- Protection class: IP54

Motor controller CMMS-ST

→ Internet: cmms-st



- Position controller with setpoint specifications for position, speed and torque
- Integrated encoder (closed loop), in other words no step losses, current following errors are corrected
- Interfaces:
 - I/O interface
 - CANopen
 - Profibus DP
 - DeviceNet

Power supply units CACN

→ Internet: cacn



- Sturdy mechanical system
- Input voltage 100 ... 240 V AC
- Output voltage 24, 48 V DC
- Output current 5, 10, 20 A

Motor and encoder cables NEBM

→ page 13



- Can be used in a wide temperature range
- Screened cables
- Suitable for use with energy chains
- Protection class IP65

Axial kits EAMM

→ Internet: eamm



- Defined kits for all electro-mechanical axes from Festo

PROFIBUS®, DeviceNet®, CANopen® is a registered trademark of its respective trademark holder in certain countries.

Stepper motors EMMS-ST

Type codes

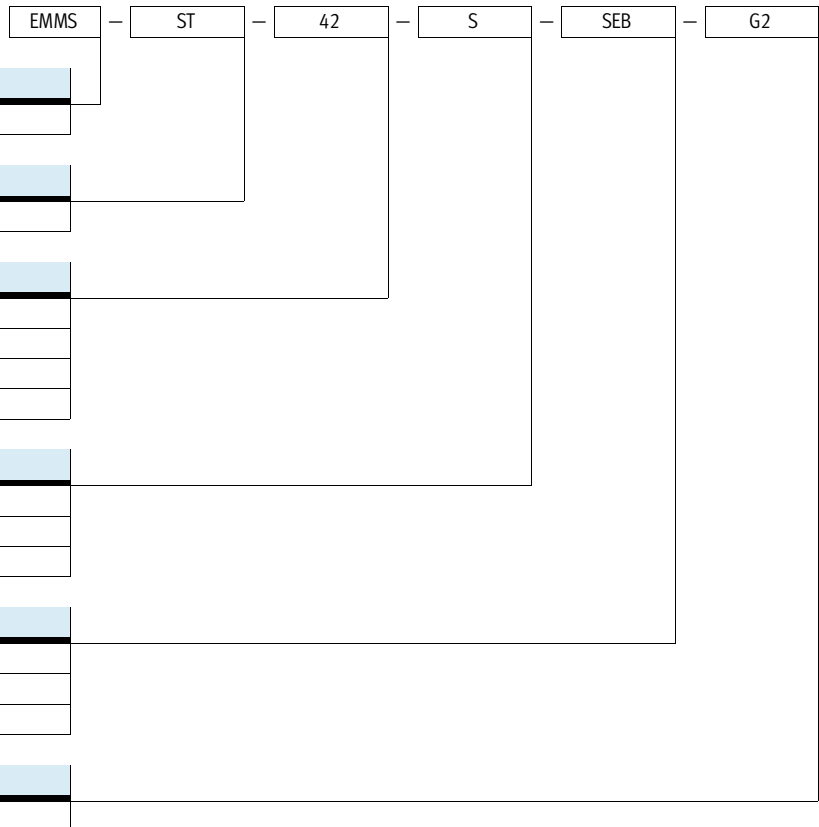

Stepper motors EMMS-ST

Technical data

FESTO

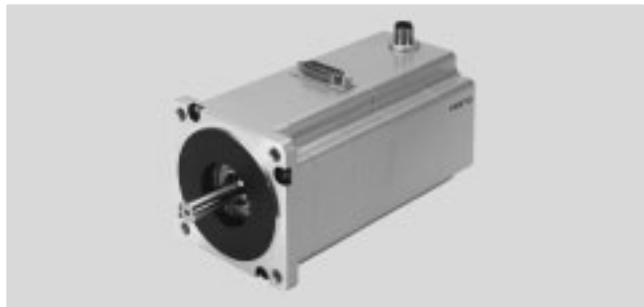

General technical data			
Size		28	42
Motor			
Nominal voltage	[V DC]	48	48
Nominal current	[A]	1.4	1.8
Max. rotational speed ¹⁾	[rpm]	6,000	1,740
Holding torque	[Nm]	0.09	0.5
Stepper angle	[°]	1.8 ±5%	1.8 ±5%
Winding resistance	[Ω]	2.3 ±15%	1.75 ±15%
Winding inductance	[mH]	1.4	3.3
Output mass moment of inertia	[kgcm ²]	0.018/0.025 ²⁾	0.082/0.095 ²⁾
Radial load on shaft	[N]	20	20
Axial load on shaft	[N]	7	7
Mass moment of inertia of rotor	[kgcm ²]	0.018	0.082
Brake			
Operating voltage	[V DC]	24 ±10%	24 ±10%
Power	[W]	8	8
Holding torque	[Nm]	0.2	0.4
Mass moment of inertia	[kgcm ²]	0.007	0.013
Response delay	[ms]	2/6	2/6
Separation time	[ms]	10	10

1) Theoretical max. rotational speed while idling at nominal voltage

2) With brake

Size		57-S	57-M
Motor			
Nominal voltage	[V DC]	48	
Nominal current	[A]	5	
Max. rotational speed ¹⁾	[rpm]	2720	1940
Holding torque	[Nm]	0.8	1.4
Stepper angle	[°]	1.8 ±5%	
Winding resistance	[Ω]	0.15 ±10%	0.25 ±10%
Winding inductance	[mH]	0.5	0.95
Output mass moment of inertia	[kgcm ²]	0.29/0.30 ²⁾	0.48/0.5 ²⁾
Radial load on shaft	[N]	52	
Axial load on shaft	[N]	10	
Mass moment of inertia of rotor	[kgcm ²]	0.29	0.48
Brake			
Operating voltage	[V DC]	24 ±10%	
Power	[W]	8	10
Holding torque	[Nm]	0.4	1
Mass moment of inertia	[kgcm ²]	0.01	0.02
Response delay	[ms]	2/6	2/6
Separation time	[ms]	10	12

1) Theoretical max. rotational speed while idling at nominal voltage

2) With brake

Stepper motors EMMS-ST

Technical data

FESTO

General technical data				
Size		87-S	87-M	87-L
Motor				
Nominal voltage	[V DC]	48		
Nominal current	[A]	9.5		
Max. rotational speed ¹⁾	[rpm]	2130	550	430
Holding torque	[Nm]	2.5	5.9	9.3
Stepper angle	[°]	1.8 ±5%		
Winding resistance	[Ω]	0.1 ±10%	0.23 ±10%	0.23 ±10%
Winding inductance	[mH]	0.45	2.6	2.7
Output mass moment of inertia	[kgcm ²]	1/1.07 ²⁾	1.9/1.97 ²⁾	3/3.07 ²⁾
Radial load on shaft	[N]	200		
Axial load on shaft	[N]	65		
Mass moment of inertia of rotor	[kgcm ²]	1	1.9	3
Brake				
Operating voltage	[V DC]	24 ±10%		
Power	[W]	11		
Holding torque	[Nm]	2		
Mass moment of inertia	[kgcm ²]	0.07		
Response delay	[ms]	2/6	2/6	2/6
Separation time	[ms]	25		

1) Theoretical max. rotational speed while idling at nominal voltage

2) With brake

Technical data – Encoder	
Rotary position encoder	Incremental
Rotary position encoder measuring principle	Opto-electrical
Pulses/revolution	[1/rev] 500
Interface	RS422, TTL, AB channel, zero index
Operating voltage	[V DC] 5

Weight [g]							
Size	28	42	57-S	57-M	87-S	87-M	87-L
Product weight	320	360	870	1100	1950	3050	4200
With encoder	380	450	970	1200	2100	3200	4350
With brake	320	540	1090	1320	2350	3450	4600
With encoder and brake	380	600	1150	1380	2500	3600	5000

Operating and environmental conditions							
Size	28	42	57-S	57-M	87-S	87-M	87-L
Insulation protection class	B						
Heat class to EN 60034-1	B						
Rated class to EN 60034-1	S1						
Protection class: Motor shaft	IP40						
Protection class: Motor housing	IP65		IP54				
Ambient temperature	[°C]	-10 ... +50					
Storage temperature	[°C]	-20 ... +70					
Relative air humidity (non-condensing)	[%]	0 ... 85					
CE marking (see declaration of conformity)	To EU EMC Directive ¹⁾						
Certification	c UL us - Recognized (OL)						
	RCM trademark						
Note on materials	RoHS-compliant						

1) For information about the applicability of the component see the manufacturer's EC declaration of conformity at: www.festo.com/sp → Certificates.

If the component is subject to restrictions on usage in residential, office or commercial environments or small businesses, further measures to reduce the emitted interference may be necessary.

Stepper motors EMMS-ST

Technical data

Pin allocation

Motor connection

Size 28

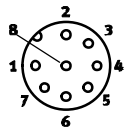

Size 42, 57

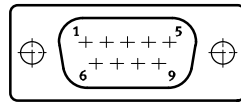

Size 87

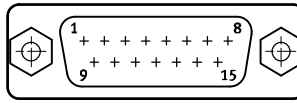

Pin	Function
1	String A
2	String A/
3	String B
4	String B/
5	n.c.
6	n.c.
7	Brake (24 V)
8	Brake (0 V)
9	–

Pin	Function
1	String A
2	String A
3	String A/
4	String A/
5	String B
6	String B
7	String B/
8	String B/
9	n.c.
10	n.c.
11	Brake (24 V)
12	Brake (0 V)
13	n.c.
14	n.c.
15	n.c.

Encoder connection

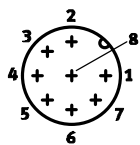

Pin	Function
1	Signal trace A
2	Signal trace A/
3	Signal trace B
4	Signal trace B/
5	0 V
6	Signal trace N
7	Signal trace N/
8	5 V

Stepper motors EMMS-ST

Technical data

Torque M as a function of rotational speed n

EMMS-ST-28

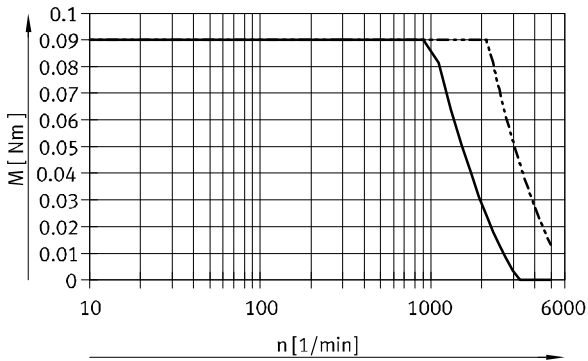

EMMS-ST-42

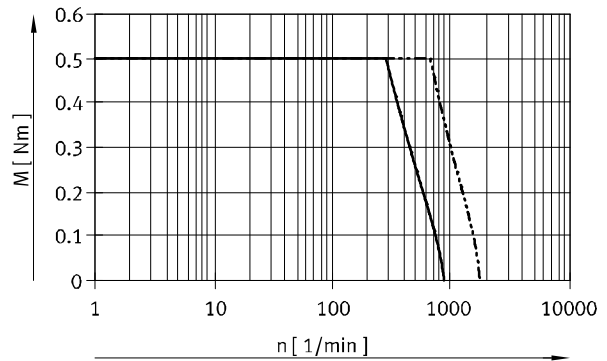

EMMS-ST-57-S

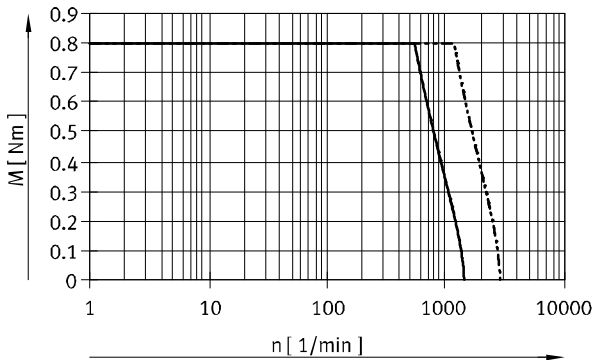

EMMS-ST-57-M

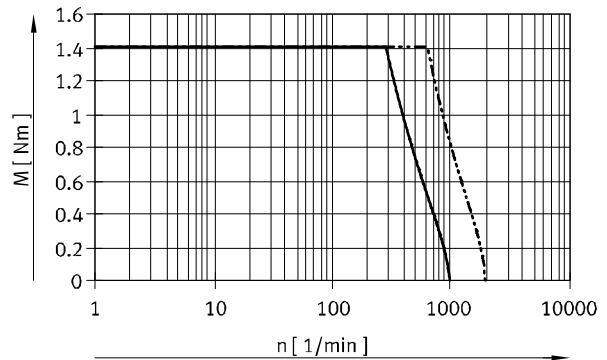

- 24 V DC
- - - 48 V DC

- - - Note

Typical motor characteristics (typical production tolerances $\pm 20\%$) at nominal voltage and with idealised motor controller.

Stepper motors EMMS-ST

Technical data

Torque M as a function of rotational speed n

EMMS-ST-87-S

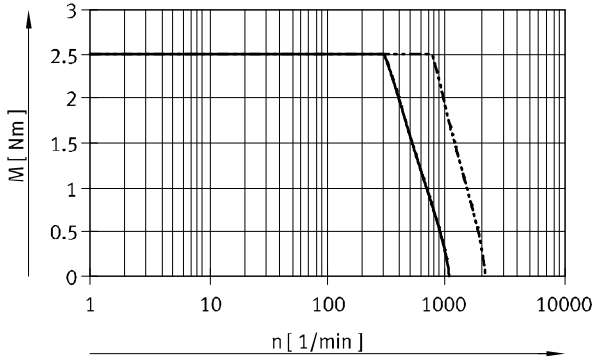

EMMS-ST-87-M

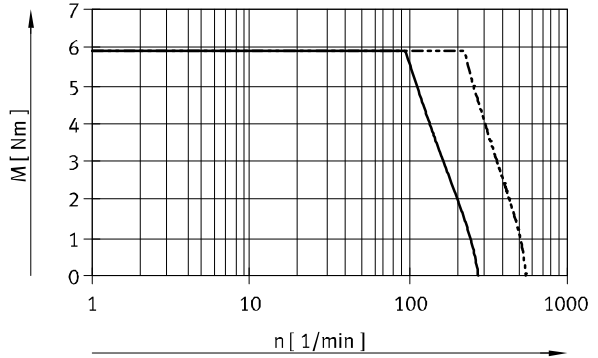

EMMS-ST-87-L

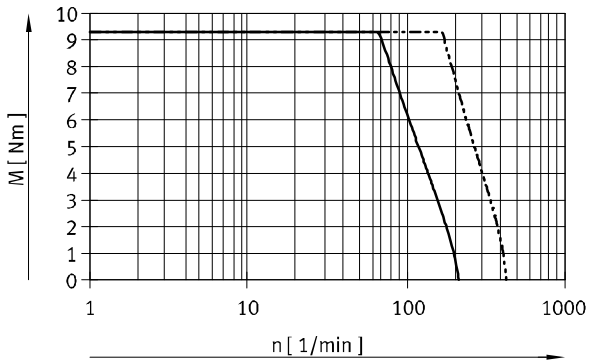

— 24 V DC
- - - 48 V DC

- - - Note

Typical motor characteristics (typical production tolerances $\pm 20\%$) at nominal voltage and with idealised motor controller.

Stepper motors EMMS-ST

Technical data

Dimensions

Download CAD data → www.festo.com

Size 28
EMMS-ST-...-S/SE

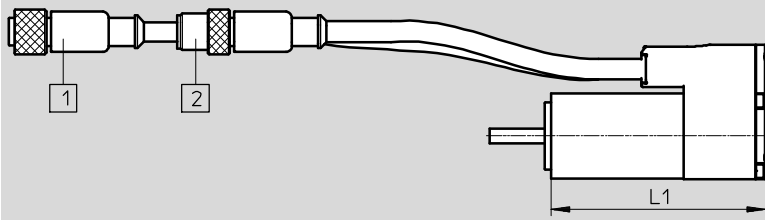

EMMS-ST-...-SB/SEB

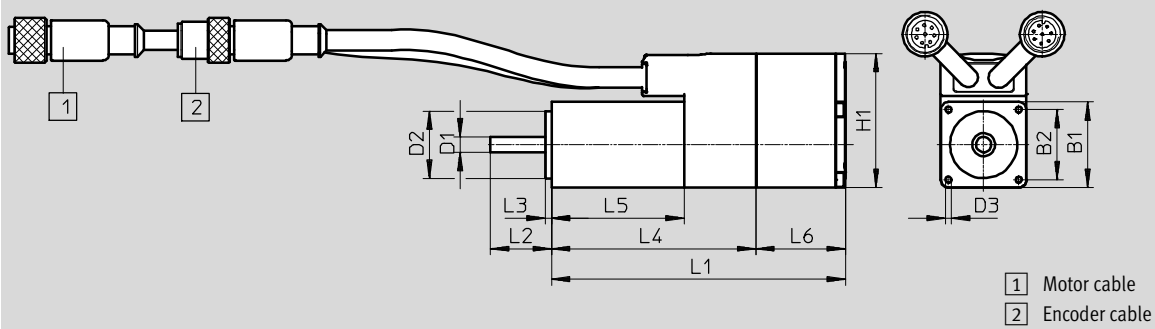

Type	B1	B2	D1	D2	D3	H1
	±1	±0.2	∅ -0.013	∅ -0.03		
EMMS-ST-28-L-S	28	23	5	22	M2.5x4.5	44
EMMS-ST-28-L-SE						
EMMS-ST-28-L-SB						
EMMS-ST-28-L-SEB						

Type	L1	L2	L3	L4	L5	L6
		±1		±1	±1	±0.5
EMMS-ST-28-L-S	70±1	20	2	67	43	-
EMMS-ST-28-L-SE						
EMMS-ST-28-L-SB	96±1.5					29
EMMS-ST-28-L-SEB						

Stepper motors EMMS-ST

Technical data

Dimensions

Download CAD data → www.festo.com

Sizes 42, 57, 87

EMMS-ST-...-S

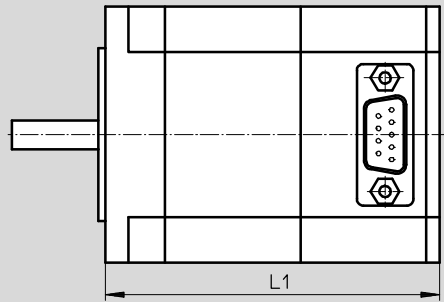

EMMS-ST-...-SB

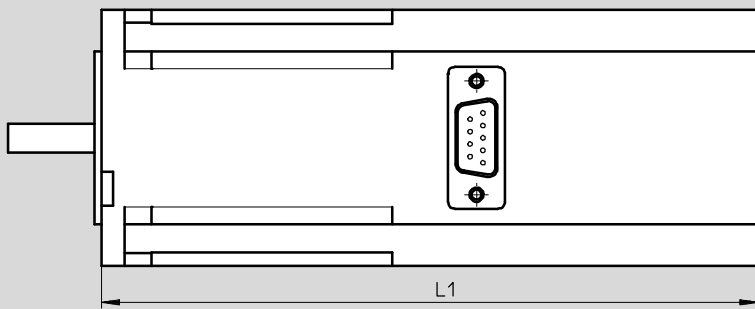

EMMS-ST-...-SE/SEB

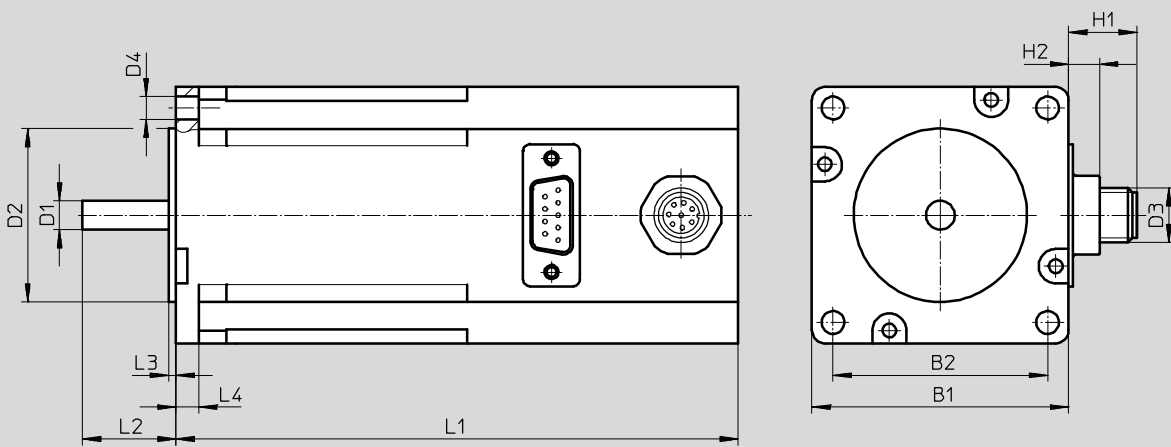

Plug pattern

9-pin Sub-D plug
with size 42, 57

15-pin Sub-D plug
with size 87

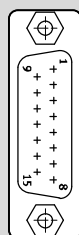
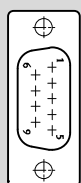

Stepper motors EMMS-ST

Technical data

FESTO

Type	B1	B2 ±0.2	D1 ∅	D2 ∅	D3	D4 ∅
EMMS-ST-42-S-S-G2	42.3	31	5-0.012	22-0.05	-	M3x4.5
EMMS-ST-42-S-SE-G2					M12	
EMMS-ST-42-S-SB-G2					-	
EMMS-ST-42-S-SEB-G2					M12	
EMMS-ST-57-S-S-G2	56.4	47.14	6.35-0.013	38.1±0.025	-	5
EMMS-ST-57-S-SE-G2					M12	
EMMS-ST-57-S-SB-G2					-	
EMMS-ST-57-S-SEB-G2					M12	
EMMS-ST-57-M-S-G2					-	
EMMS-ST-57-M-SE-G2					M12	
EMMS-ST-57-M-SB-G2					-	
EMMS-ST-57-M-SEB-G2					M12	
EMMS-ST-87-S-S-G2	85.85	69.5	11-0.013	73-0.046	-	6.6
EMMS-ST-87-S-SE-G2					M12	
EMMS-ST-87-S-SB-G2					-	
EMMS-ST-87-S-SEB-G2					M12	
EMMS-ST-87-M-S-G2					-	
EMMS-ST-87-M-SE-G2					M12	
EMMS-ST-87-M-SB-G2					-	
EMMS-ST-87-M-SEB-G2					M12	
EMMS-ST-87-L-S-G2					-	
EMMS-ST-87-L-SE-G2					M12	
EMMS-ST-87-L-SB-G2					-	
EMMS-ST-87-L-SEB-G2					M12	

Type	H1	H2	L1	L2	L3	L4	
EMMS-ST-42-S-S-G2	-	6.5	66±1	24±1	2	-	
EMMS-ST-42-S-SE-G2	13		94±1.2				
EMMS-ST-42-S-SB-G2	-		114±1.3				
EMMS-ST-42-S-SEB-G2	13		127±1.3				
EMMS-ST-57-S-S-G2	-	6.5	73.5±0.8	20.6±0.5	1.6	5	
EMMS-ST-57-S-SE-G2	13		102.5±1.1				
EMMS-ST-57-S-SB-G2	-		123.5±1.1				
EMMS-ST-57-S-SEB-G2	13		138±1.1				
EMMS-ST-57-M-S-G2	-		95±0.8				
EMMS-ST-57-M-SE-G2	13		124±1.1				
EMMS-ST-57-M-SB-G2	-		145±1.1				
EMMS-ST-57-M-SEB-G2	13		159.5±1.1				
EMMS-ST-87-S-S-G2	-	6.5	82.6±1	27±1	2	8.38	
EMMS-ST-87-S-SE-G2	13		112.6±1.3				
EMMS-ST-87-S-SB-G2	-		132.6±1.3				
EMMS-ST-87-S-SEB-G2	13		152.6±1.3				
EMMS-ST-87-M-S-G2	-		114.9±1				
EMMS-ST-87-M-SE-G2	13		144.9±1.3				
EMMS-ST-87-M-SB-G2	-		164.9±1.3				
EMMS-ST-87-M-SEB-G2	13		184.9±1.3				
EMMS-ST-87-L-S-G2	-		6.5	144.9±1	27±1	2	8.38
EMMS-ST-87-L-SE-G2	13			174.9±1.3			
EMMS-ST-87-L-SB-G2	-			194.9±1.3			
EMMS-ST-87-L-SEB-G2	13			214.9±1.3			

Stepper motors EMMS-ST

Technical data

FESTO

★ Core product range

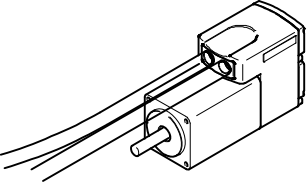
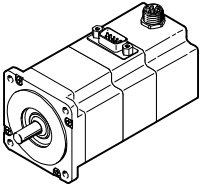
Ordering data	Size	Variant			Part No.	Type
		Basic design	With encoder	With brake		
	28	■			★ 1451384	EMMS-ST-28-L-S
			■		★ 1430663	EMMS-ST-28-L-SE
				■	★ 1451383	EMMS-ST-28-L-SB
			■	■	★ 1451382	EMMS-ST-28-L-SEB
	42	■			★ 1370470	EMMS-ST-42-S-S-G2
			■		★ 1370471	EMMS-ST-42-S-SE-G2
				■	★ 1370472	EMMS-ST-42-S-SB-G2
			■	■	★ 1370473	EMMS-ST-42-S-SEB-G2
	57	■			★ 1370474	EMMS-ST-57-S-S-G2
			■		★ 1370475	EMMS-ST-57-S-SE-G2
				■	★ 1370476	EMMS-ST-57-S-SB-G2
			■	■	★ 1370477	EMMS-ST-57-S-SEB-G2
		■			★ 1370478	EMMS-ST-57-M-S-G2
			■		★ 1370479	EMMS-ST-57-M-SE-G2
				■	★ 1370480	EMMS-ST-57-M-SB-G2
			■	■	★ 1370481	EMMS-ST-57-M-SEB-G2
	87	■			★ 1370482	EMMS-ST-87-S-S-G2
			■		★ 1370483	EMMS-ST-87-S-SE-G2
				■	★ 1370484	EMMS-ST-87-S-SB-G2
			■	■	★ 1370485	EMMS-ST-87-S-SEB-G2
		■			★ 1370486	EMMS-ST-87-M-S-G2
			■		★ 1370487	EMMS-ST-87-M-SE-G2
				■	★ 1370488	EMMS-ST-87-M-SB-G2
		■	■	★ 1370489	EMMS-ST-87-M-SEB-G2	
■				★ 1370490	EMMS-ST-87-L-S-G2	
		■		★ 1370491	EMMS-ST-87-L-SE-G2	
		■	★ 1370493	EMMS-ST-87-L-SB-G2		
	■	■	★ 1370494	EMMS-ST-87-L-SEB-G2		

Festo core product range

★ Generally ready for shipping ex works in 24 hours

☆ Generally ready for shipping ex works in 5 days

Stepper motors EMMS-ST

Accessories

FESTO

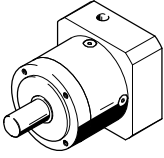
Ordering data – Gear unit				
	Motor interface	Gear ratio	Part No.	Type
	42A	3	★ 549428	EMGA-40-P-G3-SST-42
		5	★ 549429	EMGA-40-P-G5-SST-42
	57A	3	★ 549430	EMGA-60-P-G3-SST-57
		5	★ 549431	EMGA-60-P-G5-SST-57
	87A	3	★ 549432	EMGA-80-P-G3-SST-87
		5	★ 549433	EMGA-80-P-G5-SST-87

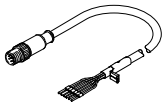
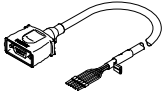
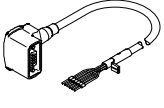
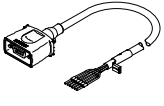
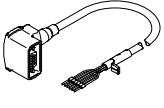
Ordering data				
	Description	Cable length [m]	Part No.	Type
Motor cable				
For EMMS-ST-28 and motor controller CMMO-ST				
	Straight plug – Min. bending radius: 62 mm – Suitable for use with energy chains – Ambient temperature: –40 ... +80 °C	1.5	★ 1449600	NEBM-SM12G8-E-1.5-Q5-LE6
		2.5	★ 1449601	NEBM-SM12G8-E-2.5-Q5-LE6
		5.0	★ 1449602	NEBM-SM12G8-E-5-Q5-LE6
		7.0	★ 1449603	NEBM-SM12G8-E-7-Q5-LE6
		10.0	★ 1449604	NEBM-SM12G8-E-10-Q5-LE6
		X length ¹⁾	1449605	NEBM-SM12G8-E-...-Q5-LE6
For EMMS-ST-42/57 and motor controller CMMS-ST/CMMO-ST				
	Straight plug – Min. bending radius: 62 mm – Suitable for use with energy chains – Ambient temperature: –40 ... +80 °C	1.5	★ 1450368	NEBM-S1G9-E-1.5-Q5-LE6
		2.5	★ 1450369	NEBM-S1G9-E-2.5-Q5-LE6
		5.0	★ 1450370	NEBM-S1G9-E-5-Q5-LE6
		7.0	★ 1450371	NEBM-S1G9-E-7-Q5-LE6
		10.0	★ 1450372	NEBM-S1G9-E-10-Q5-LE6
		X length ¹⁾	1450373	NEBM-S1G9-E-...-Q5-LE6
	Angled plug – Min. bending radius: 62 mm – Suitable for use with energy chains – Ambient temperature: –40 ... +80 °C	1.5	★ 1450736	NEBM-S1W9-E-1.5-Q5-LE6
		2.5	★ 1450737	NEBM-S1W9-E-2.5-Q5-LE6
		5.0	★ 1450738	NEBM-S1W9-E-5-Q5-LE6
		7.0	★ 1450739	NEBM-S1W9-E-7-Q5-LE6
		10.0	★ 1450740	NEBM-S1W9-E-10-Q5-LE6
		X length ¹⁾	1450741	NEBM-S1W9-E-...-Q5-LE6
For EMMS-ST-87 and motor controller CMMS-ST/CMMO-ST				
	Straight plug – Min. bending radius: 80 mm – Suitable for use with energy chains – Ambient temperature: –40 ... +80 °C	1.5	★ 1450834	NEBM-S1G15-E-1.5-Q7-LE6
		2.5	★ 1450835	NEBM-S1G15-E-2.5-Q7-LE6
		5.0	★ 1450836	NEBM-S1G15-E-5-Q7-LE6
		7.0	★ 1450837	NEBM-S1G15-E-7-Q7-LE6
		10.0	★ 1450838	NEBM-S1G15-E-10-Q7-LE6
		X length ¹⁾	1450839	NEBM-S1G15-E-...-Q7-LE6
	Angled plug – Min. bending radius: 80 mm – Suitable for use with energy chains – Ambient temperature: –40 ... +80 °C	1.5	★ 1450943	NEBM-S1W15-E-1.5-Q7-LE6
		2.5	★ 1450944	NEBM-S1W15-E-2.5-Q7-LE6
		5.0	★ 1450945	NEBM-S1W15-E-5-Q7-LE6
		7.0	★ 1450946	NEBM-S1W15-E-7-Q7-LE6
		10.0	★ 1450947	NEBM-S1W15-E-10-Q7-LE6
		X length ¹⁾	1450948	NEBM-S1W15-E-...-Q7-LE6

1) Max. 25 m. Available in 0.1 m increments.

Festo core product range

- ★ Generally ready for shipping ex works in 24 hours
- ☆ Generally ready for shipping ex works in 5 days

Stepper motors EMMS-ST

Accessories

FESTO

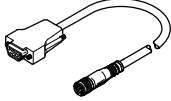
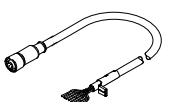
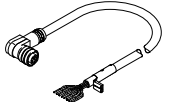
Ordering data				
	Description	Cable length [m]	Part No.	Type
Encoder cable				
For motor controller CMMS-ST				
	Straight plug			
	- Min. bending radius: 51 mm	5.0	★ 550748	NEBM-M12G8-E-5-S1G9
	- Suitable for use with energy chains	10.0	★ 550749	NEBM-M12G8-E-10-S1G9
	- Ambient temperature:	15.0	★ 550750	NEBM-M12G8-E-15-S1G9
	-40 ... +70 °C	X length ¹⁾	550751	NEBM-M12G8-E-...-S1G9
For motor controller CMMO-ST				
	Straight plug			
	- Min. bending radius: 68 mm	1.5	★ 1451586	NEBM-M12G8-E-1.5-LE8
	- Suitable for use with energy chains	2.5	★ 1451587	NEBM-M12G8-E-2.5-LE8
	- Ambient temperature:	5.0	★ 1451588	NEBM-M12G8-E-5-LE8
	-40 ... +80 °C	7.0	★ 1451589	NEBM-M12G8-E-7-LE8
		10.0	★ 1451590	NEBM-M12G8-E-10-LE8
	X length ¹⁾	1451591	NEBM-M12G8-E-...-LE8	
	Angled plug			
	- Min. bending radius: 68 mm	1.5	★ 1451674	NEBM-M12W8-E-1.5-LE8
	- Suitable for use with energy chains	2.5	★ 1451675	NEBM-M12W8-E-2.5-LE8
	- Ambient temperature:	5.0	★ 1451676	NEBM-M12W8-E-5-LE8
	-40 ... +80 °C	7.0	★ 1451677	NEBM-M12W8-E-7-LE8
		10.0	★ 1451678	NEBM-M12W8-E-10-LE8
	X length ¹⁾	1451679	NEBM-M12W8-E-...-LE8	

1) Max. 25 m. Available in 0.1 m increments.

-  - Note

The cable of angled cables may project into the area of the axis/drive!

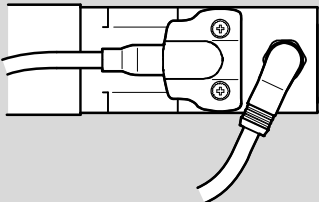

Festo core product range

★ Generally ready for shipping ex works in 24 hours

☆ Generally ready for shipping ex works in 5 days